

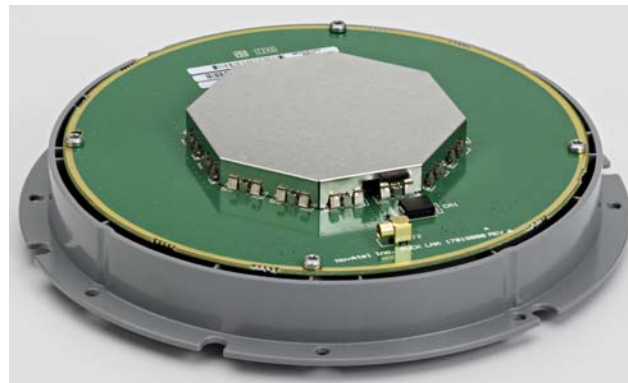

A Precise Positioning Technology Company



# Pinwheel™ OEM Integrator Manual

OM-20000142

Rev 2

April 2014



---

## Pinwheel OEM Integrator Manual

*Publication Number:* OM-20000142  
*Revision Level:* 2  
*Revision Date:* April 2014

### Warranty

NovAtel® Inc. warrants that its GNSS products are free from defects in materials and workmanship, subject to the conditions set forth on our web site: <http://www.novatel.com/products/warranty/>.

Antenna Module

One (1) Year

### Return Instructions

To return products, refer to the instructions found under the Return Policy Tab on the warranty page: <http://www.novatel.com/products/warranty/>.

### Proprietary Notice

Information in this document is subject to change without notice and does not represent a commitment on the part of NovAtel Inc. The software described in this document is furnished under a licence agreement or non-disclosure agreement. The software may be used or copied only in accordance with the terms of the agreement. It is against the law to copy the software on any medium except as specifically allowed in the license or non-disclosure agreement.

The information contained within this manual is believed to be true and correct at the time of publication.

NovAtel, Pinwheel and OEM6 are registered trademarks of NovAtel Inc.

All other brand names are trademarks of their respective holders.

Manufactured and protected under U.S. patents:

#6,445,354 B1

#6,452,560 B2

#7,250,916

© *Copyright 2014 NovAtel Inc. All rights reserved.*

Unpublished rights reserved under International copyright laws.

# Table of Contents

Customer Support .....	4
Notices.....	5
<b>1 Introduction .....</b>	<b>7</b>
Figure 1 Integration Overview .....	7
1.1 Available Signals .....	8
1.2 Additional Equipment Required .....	8
<b>2 Setup .....</b>	<b>9</b>
2.1 Pinwheel OEM Module .....	9
2.2 Integrator Chassis Construction .....	9
Figure 2 Pinwheel OEM Module Integration .....	9
2.2.1 Shield .....	10
Figure 3 Metal Location Warning .....	10
2.2.2 Connector .....	10
2.2.3 Cabling .....	10
2.3 Radome Construction .....	10
2.3.1 Radome Materials .....	10
2.3.2 Radome Shape .....	11
2.3.3 Radome Thickness .....	11
2.3.4 Radome Color .....	11
2.3.5 Radome Location .....	11
<b>ATechnical Specifications .....</b>	<b>12</b>
Figure 4 Pinwheel OEM Dimensions .....	12
Table 1 Pinwheel OEM Specifications .....	13
<b>BElectrostatic Discharge (ESD) Practices.....</b>	<b>15</b>
Table 2 Static-Accumulating Materials .....	16
Troubleshooting.....	17

# Customer Support

## NovAtel Knowledge Base

If a technical issue occurs, visit the NovAtel support website at [www.novatel.com | Support](http://www.novatel.com | Support) and search for general information about GNSS and other technologies, information about NovAtel hardware, software, installation and operation issues.



## Contact Information

Contact NovAtel Customer Support using one of the following methods:

Call the NovAtel Hotline at 1-800-NOVATEL (U.S. and Canada) or +1-403-295-4500 (international)	
Fax: +1-403-295-4501 E-mail: <a href="mailto:support@novatel.com">support@novatel.com</a> website: <a href="http://www.novatel.com">www.novatel.com</a>	Write: NovAtel Inc. Customer Support 1120 - 68 Avenue NE Calgary, AB Canada, T2E 8S5

## Conventions

Conventions used in this manual are the following:

	Note that provides information to supplement or clarify the accompanying text.
	Caution that a certain action, operation or configuration may result in incorrect or improper use of the product.
	Warning that a certain action, operation or configuration may result in regulatory noncompliance, safety issues or equipment damage.

# Notices

## WEEE

If you purchased your Pinwheel OEM family product in Europe, please return it to your dealer or supplier at the end of life. The objectives of the European Community's environment policy are, in particular, to preserve, protect and improve the quality of the environment, protect human health and utilise natural resources prudently and rationally. Sustainable development advocates the reduction of wasteful consumption of natural resources and the prevention of pollution. Waste Electrical and Electronic Equipment (WEEE) is a regulated area. Where the generation of waste cannot be avoided, it should be reused or recovered for its material or energy. WEEE products may be recognized by their wheeled bin label ().<sup>1</sup>

## RoHS

The Pinwheel OEM is compliant with the European Union (EU) Restriction of Hazardous Substances (RoHS) Directive 2011/65/EU.

## REACH

NovAtel strives to comply with the EU Directive EC 1907/2006 on chemicals and their safe use as per the Registration, Evaluation, Authorization and Restriction of Chemical substances (REACH) for its products, including the Pinwheel OEM product. Since REACH SVHC lists are updated occasionally, please contact NovAtel Customer Support if you require further information.

## Lightning Protection Installation and Grounding Procedure

*What is the hazard?*

A lightning strike into the ground causes an increase in the earth's potential which results in a high voltage potential between the center conductor and shield of the coaxial cable. This high voltage develops because the voltage surge induced onto the center conductor lags in time behind the voltage surge induced onto the shield.

*Hazard Impact*

A lightning strike causes the ground potential in the area to rise to dangerous levels resulting in harm to personnel or destruction of electronic equipment in an unprotected environment. It also conducts a portion of the strike energy down the inner conductor of the coax cable to the connected equipment.



Only qualified personnel, such as electricians mandated by the governing body in the country of installation, may install lightning protection devices.

*Actions to Mitigate Lightning Hazards*

1. Do not install antennas or antenna coaxial cables outside the building during a lightning storm.
2. It is not possible to avoid over voltages caused by lightning, but a lightning protection device may be used to shunt a large portion of the transient energy to the building ground, reducing the over voltage condition as quickly as possible.
3. Primary lightning protection must be provided by the operator/customer according to local building codes as part of the extra building installation.
4. To ensure compliance with clause 7 "Connection to Cable Distribution Systems" of EN 60950-1, Safety for Information Technology Equipment, a secondary lightning protection device must be used for in-building equipment installations with external antennas. The following device has been approved by NovAtel Inc.:
5. Polyphaser - Surge Arrestor DGXZ+24NFNF-A

---

1. See [www.novatel.com | Products | WEEE and RoHS](http://www.novatel.com | Products | WEEE and RoHS) for more information.

## Notices

6. If this device is not chosen as the primary lightning protection device, the device chosen must meet the following requirements:
7. UL listed, or equivalent, in country of installation (for example, TUV, VDE and so on) for lightning surge protection
8. The primary device must be capable of limiting an incoming surge to 10 kV
9. The shield of the coaxial cable entering the building should be connected at a grounding plate at the building's entrance. The lightning protection devices should have their chassis grounded to the same ground near to the building's entrance.
10. The primary and secondary lightning protections should be as close to the building's entrance as possible. Where feasible, mount onto the grounding plate itself (refer to the figure below).

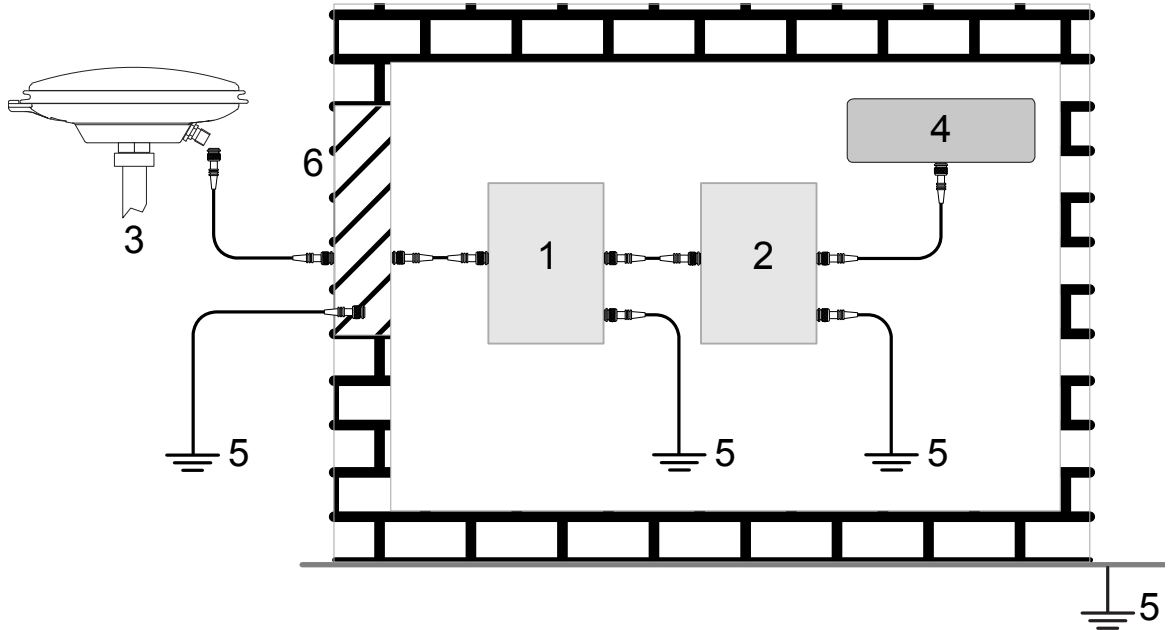

Ref #	Description	Ref #	Description
1	Primary lightning protection device	4	GNSS Receiver
2	Secondary lightning protection device	5	To ground
3	External antenna	6	Grounding plate or grounding point at the building's entrance



Acceptable choices for earth grounds, for central buildings, are:

- Grounded interior metal cold water pipe within five feet (1.5 m) of the point where it enters the building
- Grounded metallic service raceway
- Grounded electrical service equipment enclosure
- Eight-foot grounding rod driven into the ground (only if bonded to the central building ground by #6, or heavier, bonding wire)

These installation instructions are the minimum requirements for receiver and antenna installations. Where applicable, follow the electrical codes for the country of installation. Examples of country codes include:

- US National Electrical Code (NFPA 70)
- Canada Canadian Electrical Code (CSA C22)
- UK British Standards Institute (BSI 7671)

The Pinwheel OEM antenna module provides NovAtel's Pinwheel™ antenna technology in a easy to integrate assembly, targeted for use in machine control and precision agriculture applications. The Pinwheel OEM delivers optimum flexibility to integrators to create high performance antennas and smart antenna products using their own industrial designs.

NovAtel 's patented Pinwheel antenna technology provides choke ring type performance in a small and lightweight integratable package.

**Figure 1: Integration Overview**

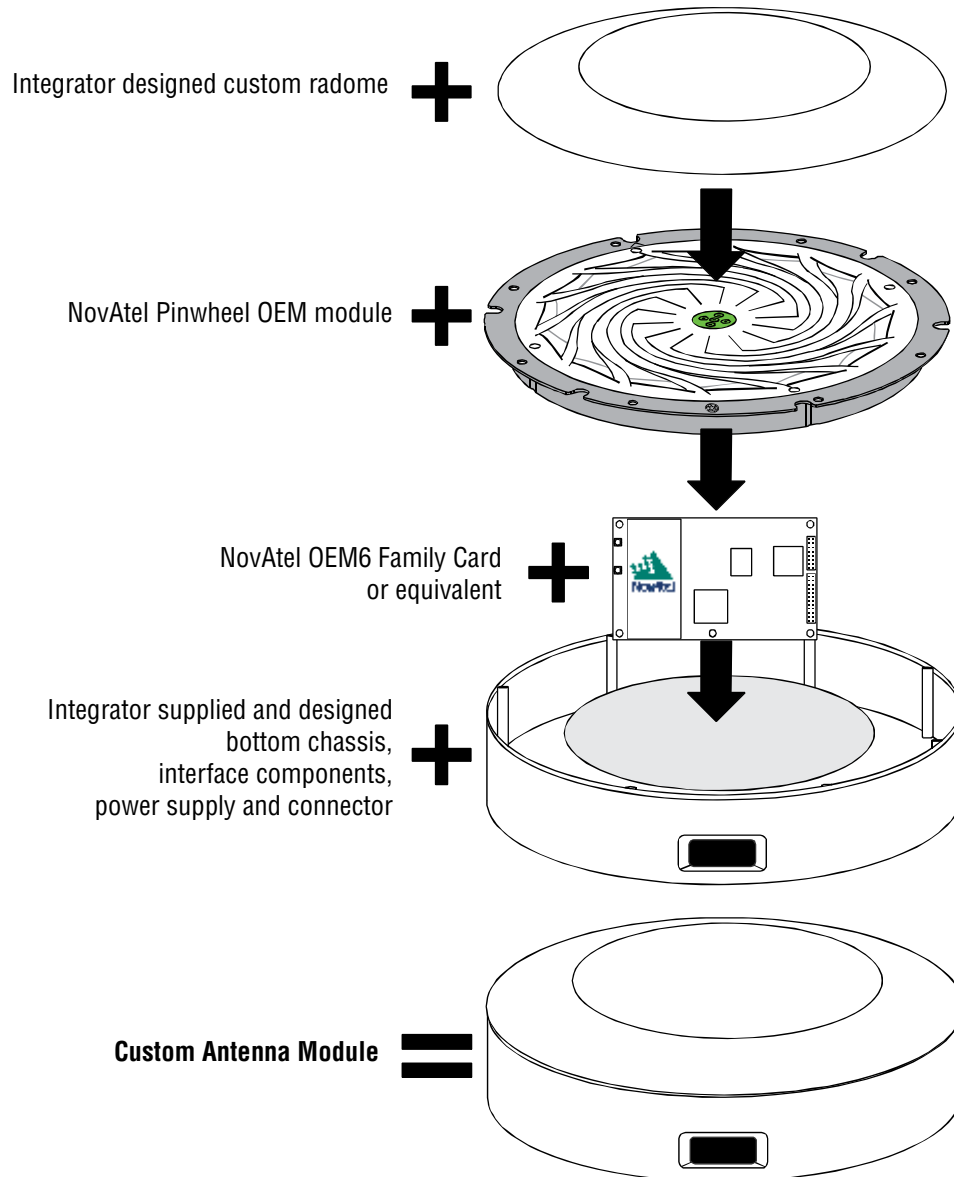

## 1.1 Available Signals

The Pinwheel OEM receives the following signals:

- L1/L2/L2C/L5 GPS
- G1/G2 GLONASS
- E1/E5a/E5b Galileo
- B1/B2 BeiDou
- L-Band

## 1.2 Additional Equipment Required

The Pinwheel OEM module comes complete and assembled.

The following additional equipment is required to fully integrate the Pinwheel OEM module.

- Integrator designed chassis (refer to *Integrator Chassis Construction* on page 9)
- Integrator designed custom radome (refer to *Radome Construction* on page 10)
- Suitable GNSS receiver such as NovAtel OEM6 Family card
- Power supply and interface circuitry to support GNSS receiver
- Cables - MMCX to customer specific connector type
- Mounting screws (x8)

Refer to the “Chapter Setup” on page 9 for details.



## 2.1 Pinwheel OEM Module

The Pinwheel OEM can be integrated with an OEM6 receiver into a dual-frequency, multi-constellation smart antenna. The Pinwheel OEM module is an assembled antenna, designed to integrate with the integrator designed radome, chassis and cabling.



Do not disassemble the Pinwheel OEM integrator chassis for any reason.

## 2.2 Integrator Chassis Construction

The Pinwheel OEM module is not hermetically sealed and must be mounted within an enclosure that prevents water and dust ingress.

The integrator chassis should be constructed using minimal metal materials. Any metal components must be located below the Pinwheel OEM antenna module (refer to *Radome Materials* on Page 10 for details).

The OEM6 receiver card used in integration should be completely shielded from the antenna module.

**Figure 2: Pinwheel OEM Module Integration**

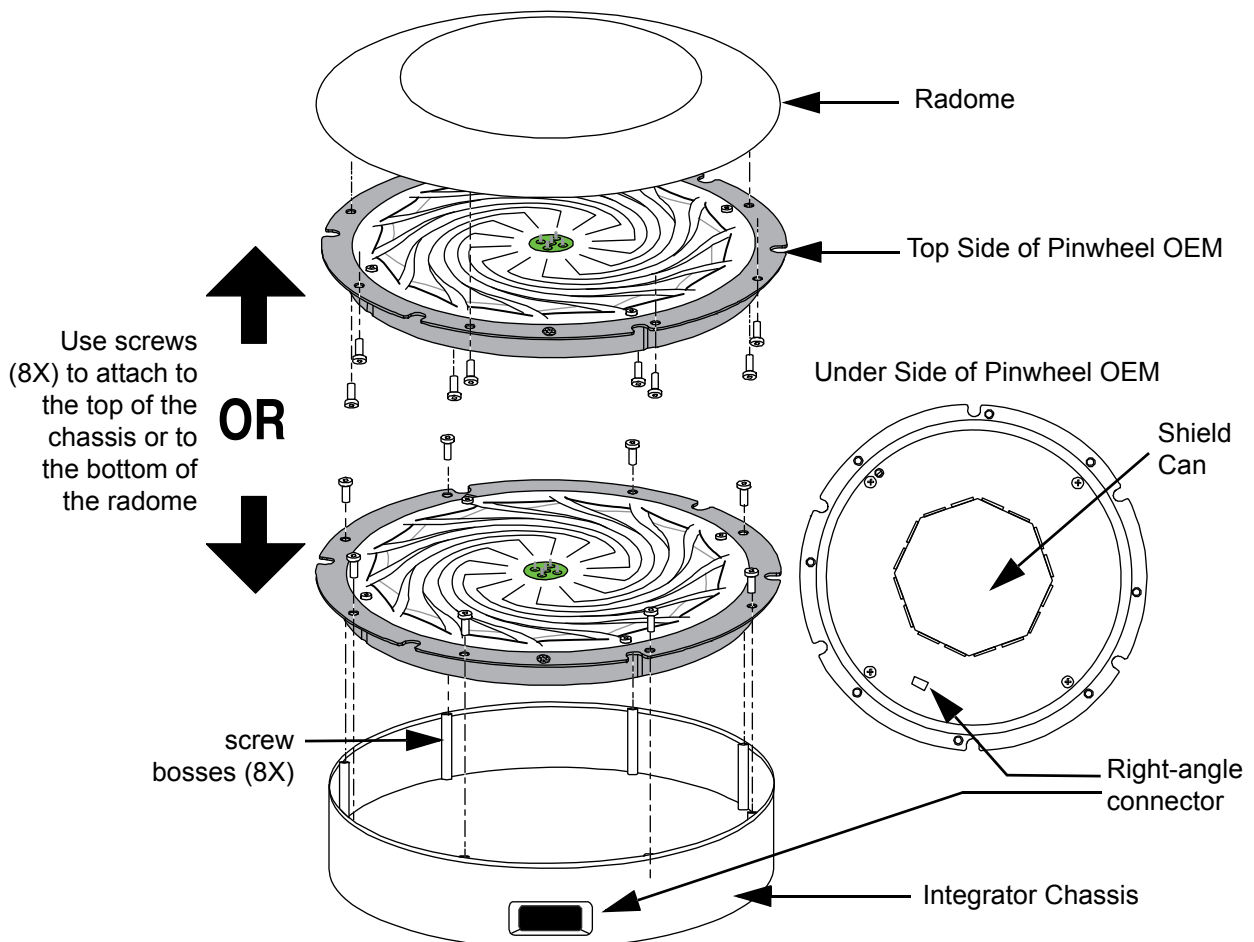



NovAtel recommends a minimum of 4 screws equally spaced around the Pinwheel OEM to hold in place (up to a maximum of 8 screws).

### 2.2.1 Shield

No metal should touch the shield can on the under side of the Pinwheel OEM module.



The use of metal casings in close proximity or on top of the antenna will degrade performance. It is recommended to use plastic bosses for mounting the antenna in the custom enclosure and keep all metal or metalized parts below the LNA shield in the custom enclosure design.

**Figure 3: Metal Location Warning**

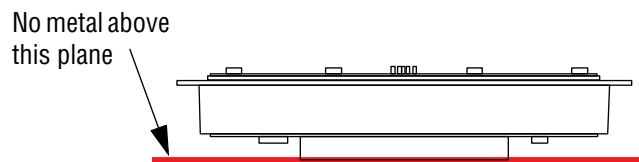

### 2.2.2 Connector

A right-angle MMCX jack is located on the under side of the Pinwheel OEM module (refer to *Figure 4, Pinwheel OEM Dimensions* on *Page 12* for location).

### 2.2.3 Cabling

A suitable RF connection (cable) between the Pinwheel OEM module and the RF connector on the receiver is required. The appropriate strain relief should be considered when selecting cables. A 50 ohm impedance is required. When using a NovAtel OEM6 receiver card, the cable loss should be 4 dB or less ( $\text{loss/m} \times \text{\# meters} = \text{cable loss}$ ).



Proper lightning protection should be used. Refer to *the Lightning Protection Installation and Grounding Procedure* section on *Page 5* for details.

## 2.3 Radome Construction

### 2.3.1 Radome Materials

The radome should be constructed from materials that provide both strength and good Radio Frequency (RF) transparency. NovAtel recommends the following materials for constructing the radome.

- G.E. Xenoy 5220
- G.E. Lexan EXL9330
- G.E. (SABIC) Valox 3900WX

These materials are mechanically stable over temperature and humidity and offer good resistance to solar radiation.



Do not completely encase or overmold the radome with plastic or foam block. A minimal distance of 5 mm should be maintained between the antenna module and the radome.

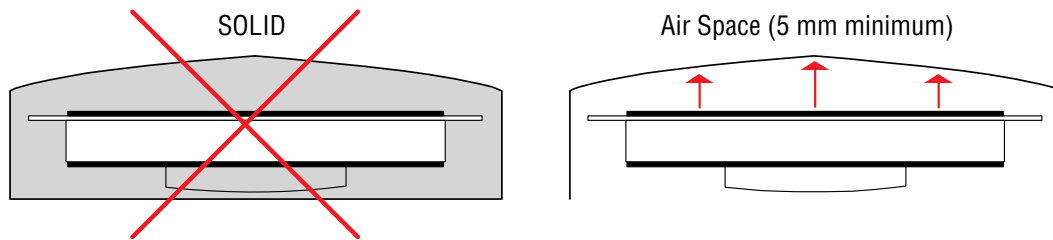

### 2.3.2 Radome Shape

The radome over the antenna should be domed or sloped to allow for water/snow runoff. Water pooling around the GNSS antenna causes multipath and other RF absorbing effects.

### 2.3.3 Radome Thickness

The thickness of the radome should be minimal while maintaining the structural integrity. A wall thickness of 2 to 2.5 mm, using the materials listed in *Section 2.3.1*, is recommended.

### 2.3.4 Radome Color

Light pigments work best as they reflect heat and tend to be more RF transparent.

### 2.3.5 Radome Location

If metal structures are required in the enclosure design, locate them as far away as possible and on the under side of the Pinwheel OEM module.



No metal should be located above the Pinwheel OEM antenna module.



The Pinwheel OEM module should not be located near high power RF transmitters. Spurious emissions produced by the RF transmitters can overload the antenna Low Noise Amplifier (LNA) and block satellite reception.

# Appendix A Technical Specifications

## A.1 Pinwheel OEM Specifications

The Pinwheel OEM has a mounting flange with eight 3 mm holes and alignment features for mounting. To maximize flexibility, the Pinwheel OEM can be mounted to screw bosses in the bottom chassis or the top radome. To minimize any signal degradation or blocking, NovAtel recommends using the bosses on the bottom of the chassis.

Figure 4: Pinwheel OEM Dimensions

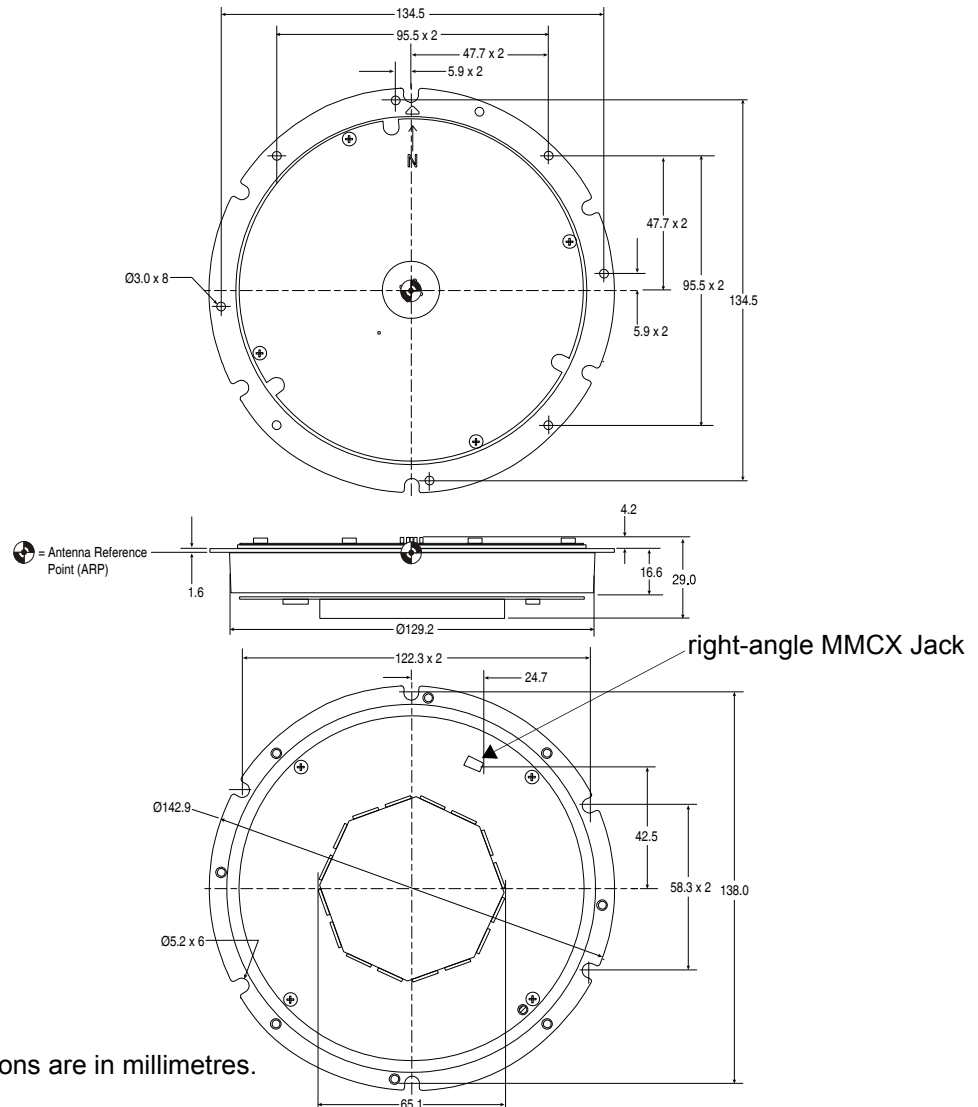

Mounting holes are keyed for consistent orientation of the Pinwheel OEM module within the integrator chassis.



Follow accepted ESD handling practices to when handling the Pinwheel OEM.

**Table 1: Pinwheel OEM Specifications**

PERFORMANCE		
Signals Tracked	GPS GLONASS BeiDou Galileo L-Band SBAS	L1, L2, L2C, L5 L1, L2 B1, B2 E1, E5a, E5b
3 dB Pass Band	L1 L-Band L2 L5, E5a E5b B2	1568 ± 43.0 MHz (typical) 1236 ± 18.3 MHz (typical) 1176.0 ± 12.0 MHz 1207.0 ± 12.0 MHz 1191.8 ± 25.0 MHz
Out-of-Band Rejection	L1, L-Band, E1, B1 L2, E5a, E5b, B2	±100 MHz 30 dBc (typical) ±200 MHz 50 dBc (typical)
LNA Gain	22 dB (typical)	
Gain at Zenith (90°)	L1 L2 E5a, L5 E5b, B2	+3.0 dBic (minimum) +1.5 dBic (minimum) -1.0 dBic (minimum) +0.0 dBic (minimum)
Gain Roll-Off (from Zenith to Horizon)	L1, L-Band, E1, B1 L2, L5, E5a, E5b, B2	12 dB 10 dB
Phase Center Stability	<3 mm <sup>1</sup>	
Noise Figure	2.5 dB (typical)	
VSWR	≤2.0 : 1	
L1-L2 Differential Propagation Delay	5 ns (maximum)	
Nominal Impedance	50 Ω	
PHYSICAL AND ELECTRICAL		
Dimensions	143 mm diameter x <30 mm	
Weight	120 g	
Power	Input Voltage Current Draw	+5.0 ±5% VDC 40 mA (typical)
Connection	MMCX right-angle female	
ENVIRONMENTAL		
Operating Temperature	-40 to +85°C	
Storage	-55°C to +85°C	
Humidity	95% non-condensing	
Vibration (operating) <sup>a</sup>	Random MIL-STD-202F Sinusoidal SAEJ211, Section 4.7	
Shock <sup>b</sup>	IEC 68-2-27 (Ea)	
Bump <sup>2b</sup>	EC 68-2-29 (Eb)	
Compliance	CE <sup>c</sup> RoHS EU Directive 2011/65/EU	

- a. As measured in NovAtel Anechoic chamber.
- b. Environmental testing validated in a NovAtel antenna enclosure.
- c. Compliant by design—not tested.

## A.2 Elevation Gain Patterns

These plots represent the typical Right Hand Polarized (RHP) and Left Hand Polarized (LHP) normalized radiation patterns for the L1 and L2 frequency bands, respectively.

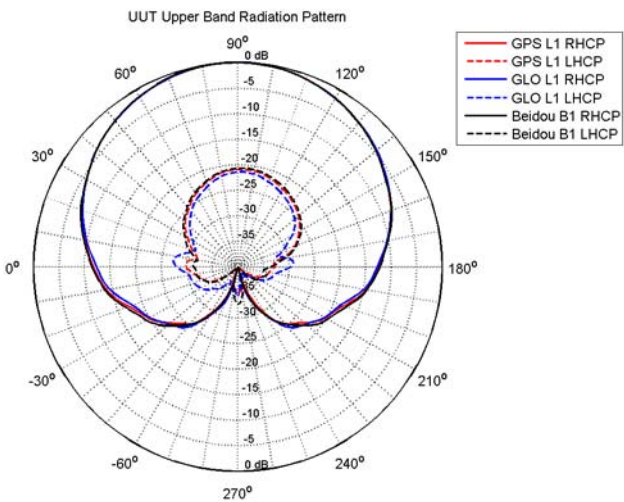
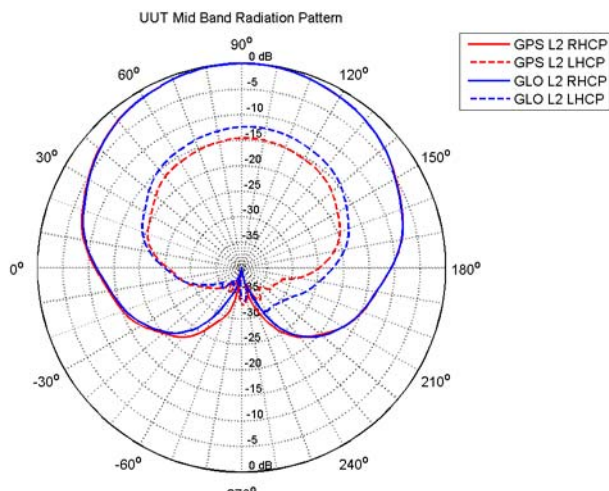
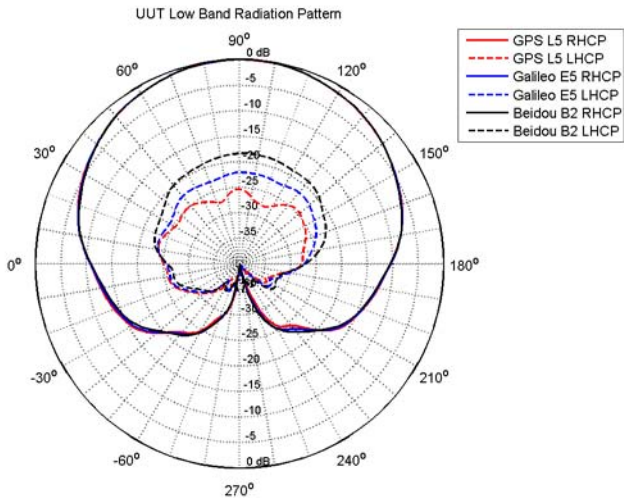

# Appendix B Electrostatic Discharge (ESD) Practices

## B.1 Overview

Static electricity is electrical charge stored in an electromagnetic field or on an insulating body. This charge can flow as soon as a low impedance path to ground is established. Static sensitive units can be permanently damaged by static discharge potentials of as little as 40 volts. Charges carried by the human body, which can be thousands of times higher than this 40 V threshold, can accumulate through as simple a mechanism as walking across non-conducting floor coverings such as carpet or tile. These charges may be stored on clothing, especially when the ambient air is dry, through friction between the body and/or various clothing layers. Synthetic materials accumulate higher charges than natural fibers. Electrostatic voltage levels on insulators may be very high, in the order of thousands of volts.

Various electrical and electronic components are vulnerable to ESD. These include discrete components, hybrid devices, Integrated Circuits (ICs) and Printed Circuit Boards (PCBs) assembled with these devices.

## B.2 Handling ESD Sensitive Devices

ESD sensitive devices must only be handled in static controlled locations. Some recommendations for such handling practices follow:

- Handling areas must be equipped with a grounded table, floor mats and wrist strap.
- A relative humidity level must be maintained between 20% and 80% non-condensing.
- No ESD sensitive board or component should be removed from its protective package, except in a static controlled location.
- A static controlled environment and correct static control procedures are required at both repair stations and maintenance areas.
- ESD sensitive devices must be handled only after personnel have grounded themselves via wrist straps and mats.
- Boards or components should never come in contact with clothing, because normal grounding cannot dissipate static charges on fabrics.
- A circuit board must be placed into a static shielding bag or clamshell before being removed from the work location and must remain in the clamshell until it arrives at a static controlled repair/test center.
- Circuit boards must not be changed or moved needlessly. Handles may be provided on circuit boards for use in their removal and replacement; care should be taken to avoid contact with the connectors and components.
- On-site repair of ESD sensitive equipment should not be undertaken except to restore service in an emergency where spare boards are not available. Under these circumstances repair station techniques must be observed. Under normal circumstances a faulty or suspect circuit board must be sent to a repair center having complete facilities or to the manufacturer for exchange or repair.
- Where protective measures have not been installed, a suitable alternative would be the use of a Portable Field Service Grounding Kit (for example, 3M Kit #8501 or #8507). This consists of a portable mat and wrist strap which must be attached to a suitable ground.
- A circuit board in a static shielding bag or clamshell may be shipped or stored in a cardboard carton, but the carton must not enter a static controlled area such as a grounded or dissipative bench top or repair zone. Do not place anything else inside the bag (for example, repair tags).
- Treat all PCBs and components as ESD sensitive. Assume that you will damage the PCB or component if you are not ESD conscious.
- Do not use torn or punctured static-shielding bags. A wire tag protruding through the bag could act as a "lightning rod", funneling the entire charge into the components inside the bag.
- Do not allow chargeable plastics, such as binders, within 0.6 m of unshielded PCBs.
- Do not allow a PCB to come within 0.3 m of a computer monitor.

---

## B.3 Prime Static Accumulators

Table 2 provides some background information on static accumulating materials.

**Table 2: Static-Accumulating Materials**

Work Surfaces	<ul style="list-style-type: none"><li>• formica (waxed or highly resistive)</li><li>• finished wood</li><li>• synthetic mats</li><li>• writing materials, note pads and so on</li></ul>
Floors	<ul style="list-style-type: none"><li>• wax-finished</li><li>• vinyl</li></ul>
Clothes	<ul style="list-style-type: none"><li>• common cleanroom smocks</li><li>• personal garments (all textiles)</li><li>• non-conductive shoes</li></ul>
Chairs	<ul style="list-style-type: none"><li>• finished wood</li><li>• vinyl</li><li>• fiberglass</li></ul>
Packing and handling	<ul style="list-style-type: none"><li>• common polyethylene bags, wraps, envelopes and bubble pack</li><li>• pack foam</li><li>• common plastic trays and tote boxes</li></ul>
Assembly, cleaning and repair areas	<ul style="list-style-type: none"><li>• spray cleaners</li><li>• common solder sucker</li><li>• common soldering irons</li><li>• common solvent brushes (synthetic bristles)</li><li>• cleaning, drying and temperature chambers</li></ul>

## B.4 Handling Printed Circuit Boards

ESD damage to unprotected sensitive devices may occur at any time. ESD events can occur far below the threshold of human sensitivity. Follow this sequence when it becomes necessary to install or remove a circuit board:

1. After you are connected to the grounded wrist strap, remove the circuit board from the frame and place it on a static controlled surface (grounded floor or table mat).
2. Remove the replacement circuit board from the static-shielding bag or clamshell and insert it into the equipment.
3. Place the original board into the shielding bag or clamshell and seal it with a label.
4. Do not put repair tags inside the shielding bag or clamshell.
5. Disconnect the wrist strap.



# Troubleshooting

These common troubleshooting tips can resolve most problems encountered. If not applicable, try our Knowledge Base at [www.novatel.com | Support](http://www.novatel.com | Support) or contact NovAtel Customer Support (refer to “*Chapter Customer Support*” on page 4 for contact details).

## Troubleshoot Issues Based on Symptoms

Symptom	Action
Receiver does not track satellites	Check cable connection between receiver and antenna Check power to receiver card Ensure that receiver has suitable input level sensitivity to operate with Pinwheel OEM including cable loss
The receiver shows “antenna open”	Check cable connections between the Pinwheel OEM and the receiver card
Un-typical Carrier to Noise (C/No) measurement ranges are experienced	Check for and remove any obstructions located above the antenna which may be blocking the sky, especially if made of metal Turn off any radio devices located nearby Move the receiver and antenna away from each other as well as away from high energy sources such as power supplies or high powered transmitters

